

ERGON[®]
LIVING

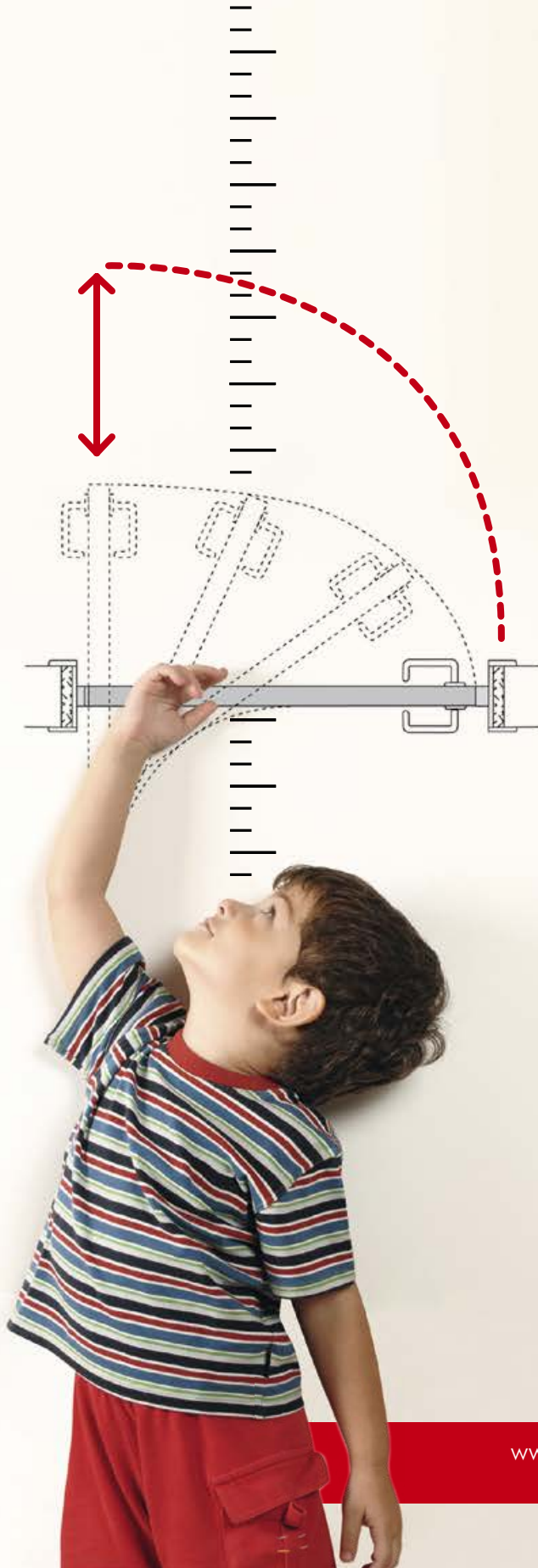

+ INCREASE
THE SPACE

50%

- REDUCE
THE VOLUME



REDUCE THE VOLUME

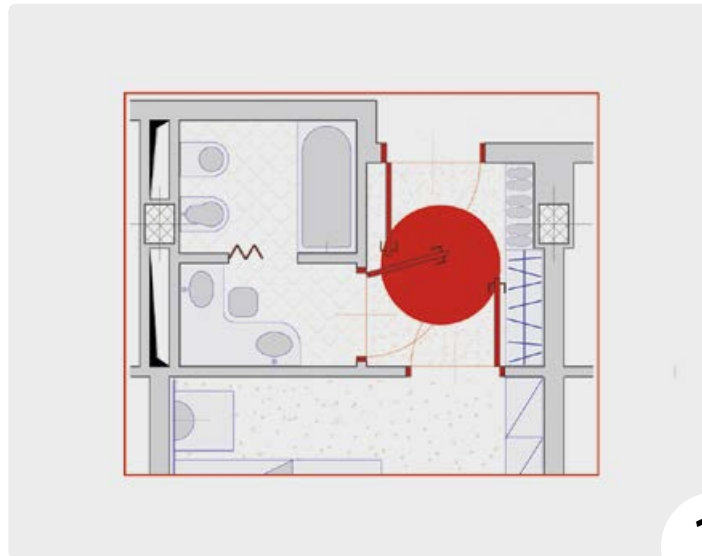

INCREASE THE SPACE

For more than 40 years, Celegon works in the furniture sector with solutions to exploit the available space, reducing the volume of doors by 50% with an innovative patented technology. ERGON[®] living is a technology that revolutionises the concept of the door: a tool which, even in the design phase, offers new alternatives to solve the problems of organising interior space, providing new furnishing perspectives even in small surroundings.

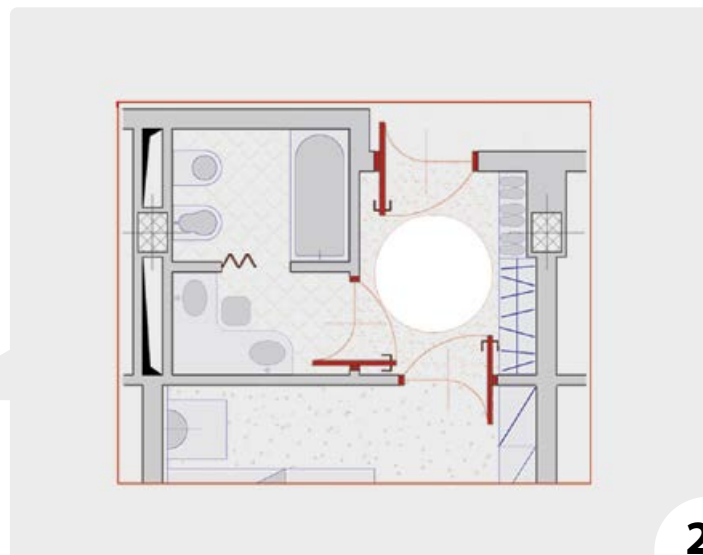

Picture 1 and in picture 2 shows interior furnishings using normal door leaves.

Thanks to the ERGON[®] living system, considerable space can be recovered even in the same surroundings, by eliminating the conflict of the doors.



SOLUTIONS FOR ALL NEEDS

ERGON® living brings a revolutionary system to the home, which reduces the volume and increases the available space.

During the design phase, the access areas can be reorganised to increase the available space in the rooms.

No more problems of bothersome doors, making access easier.

In fact, as it can be opened from both sides, you can enter or leave the room by just pushing the door which then quickly closes behind you.

The double opening direction is the ideal solution to emergency doors and these features are also practical for the disabled.

The simultaneous rotating and translating movement of the door during opening and closing means that the volume is reduced to a minimum, making access easy even to very small rooms. The push system is as practical as any other normal door leaf.

DOOR WITH ERGON LIVING® SYSTEM

example of the measurements:

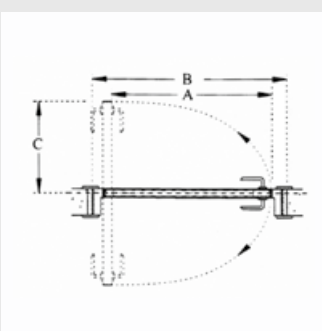

WIDTH

Useful passage width	A	640	690	740	790	840	890	940
Internal width of the back-frame	B	800	850	900	950	1000	1050	1100
Maximum volume of the door open with the panel flush to the wall	C	392	392	392	428	478	528	578

HEIGHT

Useful passage height		1900	1950	2000	2050	2100	2150	2200
Height of the back-frame from the floor		1950	2000	2050	2100	2150	2200	2250

A KIT FOR EACH DOOR

FROM HOLLOW CORED TO SOLID WOOD

ERGON® living is a kit that revolutionises the concept of a door: a tool which, even in the design phase, increases interior space, providing new furnishing perspectives even in small surroundings.

ERGON® living is a swinging sliding technology and a valid alternative to all other opening systems. No brickwork is needed. There are no limitations to the interior design, because the system is ideal for any sort of support, wood, glass, metal or plastic doors.

The ERGON® system is available from authorised retailers.



PATENTED

AN EXCLUSIVE CELEGON IDEA

The ERGON® system has successfully passed the strict CATAS testing of 100,000 openings. ERGON® living is a Celegon brand that has been registered in the leading world markets.

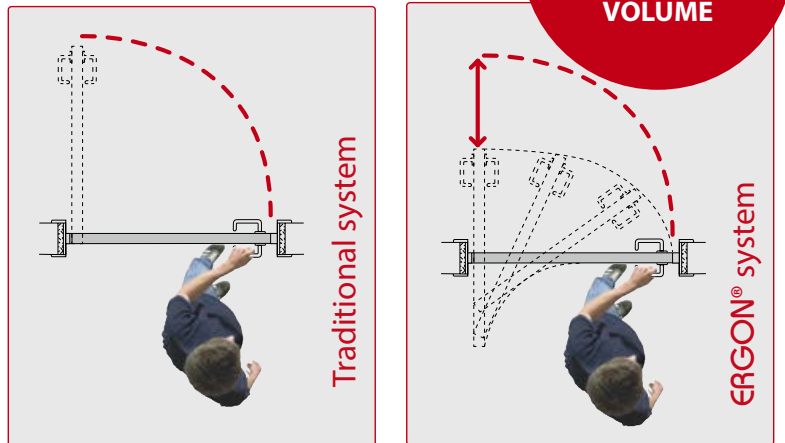

ERGON LIVING + SOFT OPENING

FROM TODAY WITH THE REVOLUTIONARY DAMPING SYSTEM



Soft Opening, the new one born in Celegon's home will make more enjoyable opening and closing the doors in your home.

Celegon has already been able to save the space of the door leaves and today, thanks to the opening system Soft applicable to the ERGON® set living, opening and closing will be more easy and safer.

Thanks to a light push, the opening Soft allows to slide and to open the door leaf softly without having to accompany it.



ROTOTRASLATION

THE CONVENIENT MOVEMENT

No brickwork and no additional costs with respect to traditional opening systems: ERGON® living is advantageous and convenient thanks to the easy to use and apply kit. With two finishes – black and silver – and more than 50 standard items of finishes and measurements, the ERGON® kit satisfies all the needs of design and furniture. Available in the standard, small and large versions, it can be mounted on different light passages..

S/40 TECHNOLOGY

FOR HOLLOW CORED DOORS

with a rotating rod inside the door panel, based on the tried and tested ERGON® community hardware.

T.E. TECHNOLOGY

FOR SOLID SECTION DOORS

with a rotating rod inside the door jamb, for applying on solid section doors.

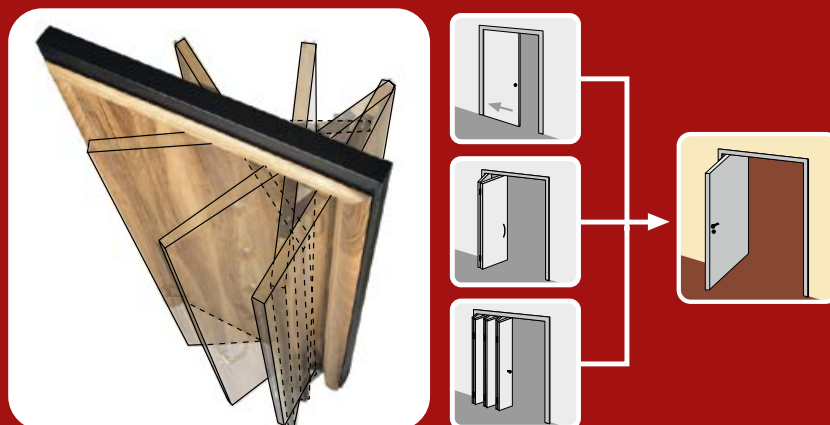

AVAILABLE SYSTEMS

LONG LIFE AND RELIABILITY

TESTED AND CERTIFIED SYSTEM

CATAS

TEST CERTIFICATE
CLASS 5
100.000 cycles carried out

ERGON® living means quality and strength. It is guaranteed by CATAS, the research and development laboratory for the wood-furniture sector, which carried out very strict tests on the strength of the system by repeated opening and closing, to then issue the Test Certificate in compliance with the EN 1191/00 standard.



MADE IN ITALY

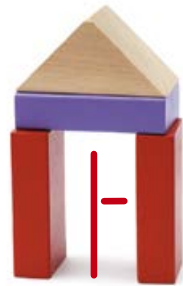

ERGON living® è un'idea CELEGON
30035 Mirano (Venezia) | Via G. Galilei, 6 - Z.I.
T +39 041 572 8404 | F +39 041 572 8522
www.ergon.eu | info@ergon.eu